

EMMA-A02

User Manual

Issue 11
Date 2025-09-30



Copyright © Huawei Digital Power Technologies Co., Ltd. 2025. All rights reserved.

No part of this document may be reproduced or transmitted in any form or by any means without prior written consent of Huawei Digital Power Technologies Co., Ltd.

Trademarks and Permissions



HUAWEI and other Huawei trademarks are the property of Huawei Technologies Co., Ltd.

All other trademarks and trade names mentioned in this document are the property of their respective holders.

Notice

The purchased products, services and features are stipulated by the contract made between Huawei Digital Power Technologies Co., Ltd. and the customer. All or part of the products, services and features described in this document may not be within the purchase scope or the usage scope. Unless otherwise specified in the contract, all statements, information, and recommendations in this document are provided "AS IS" without warranties, guarantees or representations of any kind, either express or implied. The information in this document is subject to change without notice. Every effort has been made in the preparation of this document to ensure accuracy of the contents, but all statements, information, and recommendations in this document do not constitute a warranty of any kind, express or implied.

Huawei Digital Power Technologies Co., Ltd.

Address: Huawei Digital Power Antuoshan Headquarters
Futian, Shenzhen 518043
People's Republic of China

Website: <https://digitalpower.huawei.com>

More Information

Huawei Digital Power Information Experience Center

<https://info.support.huawei.com/Energy/info>



About This Document

Purpose

SmartAssistant is a smart home energy controller. EMMA-A02 is one of its models.

This document describes the SmartAssistant in terms of safety precautions, product introduction, installation, electrical connections, power-on and commissioning, maintenance, and technical data. Read this document carefully before installing and using the SmartAssistant.





Intended Audience

This document is intended for:

- Technical support engineers
- Hardware installation engineers
- Commissioning engineers
- Maintenance engineers

Symbol Conventions

The symbols that may be found in this document are defined as follows.

Symbol	Description
	Indicates a hazard with a high level of risk which, if not avoided, will result in death or serious injury.
	Indicates a hazard with a medium level of risk which, if not avoided, could result in death or serious injury.
	Indicates a hazard with a low level of risk which, if not avoided, could result in minor or moderate injury.
	Indicates a potentially hazardous situation which, if not avoided, could result in equipment damage, data loss, performance deterioration, or unanticipated results. NOTICE is used to address practices not related to personal injury.

Symbol	Description
 NOTE	Supplements the important information in the main text. NOTE is used to address information not related to personal injury, equipment damage, and environment deterioration.

Change History

Issue	Date	Description
11	2025-09-30	<ul style="list-style-type: none">Updated About This Document.Updated 2.1 Model Number Description.Changed "Energy Management Assistant" to "SmartAssistant" throughout the document.
10	2025-07-25	Updated 5.1 Preparing Cables .
09	2025-07-01	<ul style="list-style-type: none">Updated 2.1 Model Number Description.Updated 2.2 Networking.Updated 5.1 Preparing Cables.Updated 5.4 Installing FE Communications Cables.Updated 6.3.1 Deploying a New Plant.Added B Connecting to the SmartAssistant on the App.Added D One-Click Network Disconnection Settings.
08	2025-02-21	<ul style="list-style-type: none">Updated 2.2 Networking.Updated 5.1 Preparing Cables.Updated 5.3 Connecting RS485 Communications Cables, DO Signal Cables, and 12 V Output Cables.Updated 5.4 Installing FE Communications Cables.Updated 5.5 (Optional) Installing External WLAN Antennas.Updated C.1 Initial Certificate Risk Disclaimer.
07	2024-05-24	<ul style="list-style-type: none">Updated 5.1 Preparing Cables.Updated 5.2 Connecting the AC Power Cable or External CT Cable.Updated 8 Technical Specifications.
06	2024-02-29	Added 7.3 Replacing a SmartAssistant .

Issue	Date	Description
05	2024-01-19	Updated 7.2 Alarm Reference .
04	2023-12-30	Updated 2.2 Networking .
03	2023-11-30	<ul style="list-style-type: none">• Updated About This Document.• Updated 2.2 Networking.• Updated 2.4 Label Description.
02	2023-10-31	Updated 2.2 Networking .
01	2023-09-15	This issue is the first official release.

Contents

About This Document.....	ii
1 Safety Information.....	1
1.1 Personal Safety.....	2
1.2 Electrical Safety.....	4
1.3 Environment Requirements.....	7
1.4 Mechanical Safety.....	9
2 Product Description.....	14
2.1 Model Number Description.....	14
2.2 Networking.....	14
2.3 Appearance.....	17
2.4 Label Description.....	19
3 Storage Requirements.....	21
4 Installation.....	22
4.1 Installation Requirements.....	22
4.2 Preparing Tools.....	22
4.3 Checking Before the Installation.....	24
4.4 Installing the SmartAssistant.....	24
5 Electrical Connections.....	26
5.1 Preparing Cables.....	27
5.2 Connecting the AC Power Cable or External CT Cable.....	30
5.3 Connecting RS485 Communications Cables, DO Signal Cables, and 12 V Output Cables.....	36
5.4 Installing FE Communications Cables.....	39
5.5 (Optional) Installing External WLAN Antennas.....	39
6 Power-On and Commissioning.....	41
6.1 Check Before Power-On.....	41
6.2 Powering On the SmartAssistant.....	42
6.3 Commissioning the SmartAssistant.....	43
6.3.1 Deploying a New Plant.....	43
6.3.2 Commissioning Functions.....	44
7 Maintenance.....	46

7.1 Routine Maintenance.....	46
7.2 Alarm Reference.....	47
7.3 Replacing a SmartAssistant.....	47
8 Technical Specifications.....	49
A Resetting Passwords.....	51
B Connecting to the SmartAssistant on the App.....	52
C Certificate Management and Maintenance.....	55
C.1 Initial Certificate Risk Disclaimer.....	55
C.2 Application Scenarios of Initial Certificates.....	56
D One-Click Network Disconnection Settings.....	57
E Contact Information.....	59
F Intelligent Customer Service.....	61
G Acronyms and Abbreviations.....	62

1 Safety Information

Statement

Before transporting, storing, installing, operating, using, and/or maintaining the equipment, read this document, strictly follow the instructions provided herein, and follow all the safety instructions on the equipment and in this document. In this document, "equipment" refers to the products, software, components, spare parts, and/or services related to this document; "the Company" refers to the manufacturer (producer), seller, and/or service provider of the equipment; "you" refers to the entity that transports, stores, installs, operates, uses, and/or maintains the equipment.

The **Danger, Warning, Caution, and Notice** statements described in this document do not cover all the safety precautions. You also need to comply with relevant international, national, or regional standards and industry practices. **The Company shall not be liable for any consequences that may arise due to violations of safety requirements or safety standards concerning the design, production, and usage of the equipment.**

The equipment shall be used in an environment that meets the design specifications. Otherwise, the equipment may be faulty, malfunctioning, or damaged, which is not covered under the warranty. The Company shall not be liable for any property loss, personal injury, or even death caused thereby.

Comply with applicable laws, regulations, standards, and specifications during transportation, storage, installation, operation, use, and maintenance.

Do not perform reverse engineering, decompilation, disassembly, adaptation, implantation, or other derivative operations on the equipment software. Do not study the internal implementation logic of the equipment, obtain the source code of the equipment software, violate intellectual property rights, or disclose any of the performance test results of the equipment software.

The Company shall not be liable for any of the following circumstances or their consequences:

- The equipment is damaged due to force majeure such as earthquakes, floods, volcanic eruptions, debris flows, lightning strikes, fires, wars, armed conflicts, typhoons, hurricanes, tornadoes, and other extreme weather conditions.
- The equipment is operated beyond the conditions specified in this document.

- The equipment is installed or used in environments that do not comply with international, national, or regional standards.
- The equipment is installed or used by unqualified personnel.
- You fail to follow the operation instructions and safety precautions on the product and in the document.
- You remove or modify the product or modify the software code without authorization.
- You or a third party authorized by you cause the equipment damage during transportation.
- The equipment is damaged due to storage conditions that do not meet the requirements specified in the product document.
- You fail to prepare materials and tools that comply with local laws, regulations, and related standards.
- The equipment is damaged due to your or a third party's negligence, intentional breach, gross negligence, or improper operations, or other reasons not related to the Company.

1.1 Personal Safety

 **DANGER**

Ensure that power is off during installation. Do not install or remove a cable with power on. Transient contact between the core of the cable and the conductor will cause electric arcs, sparks, fire, or explosion, which may result in personal injury.

 **DANGER**

Non-standard and improper operations on the energized equipment may cause fire, electric shocks, or explosion, resulting in property damage, personal injury, or even death.

 **DANGER**

Before operations, remove conductive objects such as watches, bracelets, bangles, rings, and necklaces to prevent electric shocks.

 **DANGER**

During operations, use dedicated insulated tools to prevent electric shocks or short circuits. The dielectric withstanding voltage level must comply with local laws, regulations, standards, and specifications.

 **DANGER**

During operations, wear personal protective equipment such as protective clothing, insulated shoes, goggles, safety helmets, and insulated gloves.

General Requirements

- Do not stop protective devices. Pay attention to the warnings, cautions, and related precautionary measures in this document and on the equipment.
- If there is a likelihood of personal injury or equipment damage during operations, immediately stop, report the case to the supervisor, and take feasible protective measures.
- Do not power on the equipment before it is installed or confirmed by professionals.
- Do not touch the power supply equipment directly or with conductors such as damp objects. Before touching any conductor surface or terminal, measure the voltage at the contact point to ensure that there is no risk of electric shock.
- Do not touch operating equipment because the enclosure is hot.
- Do not touch a running fan with your hands, components, screws, tools, or boards. Otherwise, personal injury or equipment damage may occur.
- In the case of a fire, immediately leave the building or the equipment area and activate the fire alarm or call emergency services. Do not enter the affected building or equipment area under any circumstances.

Personnel Requirements

- Only professionals and trained personnel are allowed to operate the equipment.
 - Professionals: personnel who are familiar with the working principles and structure of the equipment, trained or experienced in equipment operations and are clear of the sources and degree of various potential hazards in equipment installation, operation, maintenance
 - Trained personnel: personnel who are trained in technology and safety, have required experience, are aware of possible hazards on themselves in certain operations, and are able to take protective measures to minimize the hazards on themselves and other people
- Personnel who plan to install or maintain the equipment must receive adequate training, be able to correctly perform all operations, and understand all necessary safety precautions and local relevant standards.
- Only qualified professionals or trained personnel are allowed to install, operate, and maintain the equipment.
- Only qualified professionals are allowed to remove safety facilities and inspect the equipment.
- Personnel who will perform special tasks such as electrical operations, working at heights, and operations of special equipment must possess the required local qualifications.
- Only certified high-voltage electricians are allowed to operate medium-voltage equipment.

- Only authorized professionals are allowed to replace the equipment or components (including software).
- Only personnel who need to work on the equipment are allowed to access the equipment.

1.2 Electrical Safety

 **DANGER**

Before connecting cables, ensure that the equipment is intact. Otherwise, electric shocks or fire may occur.

 **DANGER**

Non-standard and improper operations may result in fire or electric shocks.

 **DANGER**

Prevent foreign matter from entering the equipment during operations. Otherwise, equipment short-circuits or damage, load power derating, power failure, or personal injury may occur.

 **CAUTION**

Do not route cables near the air intake or exhaust vents of the equipment.

General Requirements

- Follow the procedures described in the document for installation, operation, and maintenance. Do not reconstruct or alter the equipment, add components, or change the installation sequence without permission.
- Obtain approval from the national or local electric utility company before connecting the equipment to the grid.
- Observe the power plant safety regulations, such as the operation and work ticket mechanisms.
- Install temporary fences or warning ropes and hang "No Entry" signs around the operation area to keep unauthorized personnel away from the area.
- Before installing or removing power cables, turn off the switches of the equipment and its upstream and downstream switches.
- If any liquid is detected inside the equipment, disconnect the power supply immediately and do not use the equipment.

- Before performing operations on the equipment, check that all tools meet the requirements and record the tools. After the operations are complete, collect all of the tools to prevent them from being left inside the equipment.
- Before installing power cables, check that cable labels are correct and cable terminals are insulated.
- When installing the equipment, use a torque tool of a proper measurement range to tighten the screws. When using a wrench to tighten the screws, ensure that the wrench does not tilt and the torque error does not exceed 10% of the specified value.
- Ensure that bolts are tightened with a torque tool and marked in red and blue after double-check. Installation personnel mark tightened bolts in blue. Quality inspection personnel confirm that the bolts are tightened and then mark them in red. (The marks must cross the edges of the bolts.)

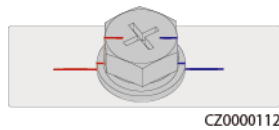

- After the installation is complete, ensure that protective cases, insulation tubes, and other necessary items for all electrical components are in position to avoid electric shocks.
- If the equipment has multiple inputs, disconnect all the inputs and wait until the equipment is completely powered off before performing operations on the equipment.
- Before maintaining a downstream electrical or power distribution device, turn off the output switch on the power supply equipment.
- During equipment maintenance, attach "Do not switch on" labels near the upstream and downstream switches or circuit breakers as well as warning signs to prevent accidental connection. The equipment can be powered on only after troubleshooting is complete.
- Do not open equipment panels.
- Check equipment connections periodically, ensuring that all screws are securely tightened.
- Only qualified professionals can replace a damaged cable.
- Do not scrawl, damage, or block any labels or nameplates on the equipment. Promptly replace labels that have worn out.
- Do not use solvents such as water, alcohol, or oil to clean electrical components inside or outside of the equipment.

Cabling Requirements

- When selecting, installing, and routing cables, follow local safety regulations and rules.
- When routing power cables, ensure that there is no coiling or twisting. Do not join or weld power cables. If necessary, use a longer cable.
- Ensure that all cables are properly connected and insulated, and meet specifications.
- Ensure that the slots and holes for routing cables are free from sharp edges, and that the positions where cables are routed through pipes or cable holes

are equipped with cushion materials to prevent the cables from being damaged by sharp edges or burrs.

- Ensure that cables of the same type are bound together neatly and straight and that the cable sheath is intact. When routing cables of different types, ensure that they are away from each other without entanglement and overlapping.
- When cable connection is completed or paused for a short period of time, seal the cable holes with sealing putty immediately to prevent small animals or moisture from entering.
- Secure buried cables using cable supports and cable clips. Ensure that the cables in the backfill area are in close contact with the ground to prevent cable deformation or damage during backfilling.
- If the external conditions (such as the cable layout or ambient temperature) change, verify the cable usage in accordance with the IEC-60364-5-52 or local laws and regulations. For example, check that the current-carrying capacity meets requirements.
- When routing cables, reserve at least 30 mm clearance between the cables and heat-generating components or areas. This prevents deterioration or damage to the cable insulation layer.
- When the temperature is low, violent impact or vibration may damage the plastic cable sheathing. To ensure safety, comply with the following requirements:
 - Cables can be laid or installed only when the temperature is higher than 0°C. Handle cables with caution, especially at a low temperature.
 - Cables stored at below 0°C must be stored at room temperature for more than 24 hours before they are laid out.
- Do not perform any improper operations, for example, dropping cables directly from a vehicle. Otherwise, the cable performance may deteriorate due to cable damage, which affects the current-carrying capacity and temperature rise.

ESD

NOTICE

The static electricity generated by human bodies may damage the electrostatic-sensitive components on boards, for example, the large-scale integrated (LSI) circuits.

-
- When touching the equipment and handling boards, modules with exposed circuit boards, or application-specific integrated circuits (ASICs), observe ESD protection regulations and wear ESD clothing and ESD gloves or a well-grounded ESD wrist strap.

Figure 1-1 Wearing an ESD wrist strap

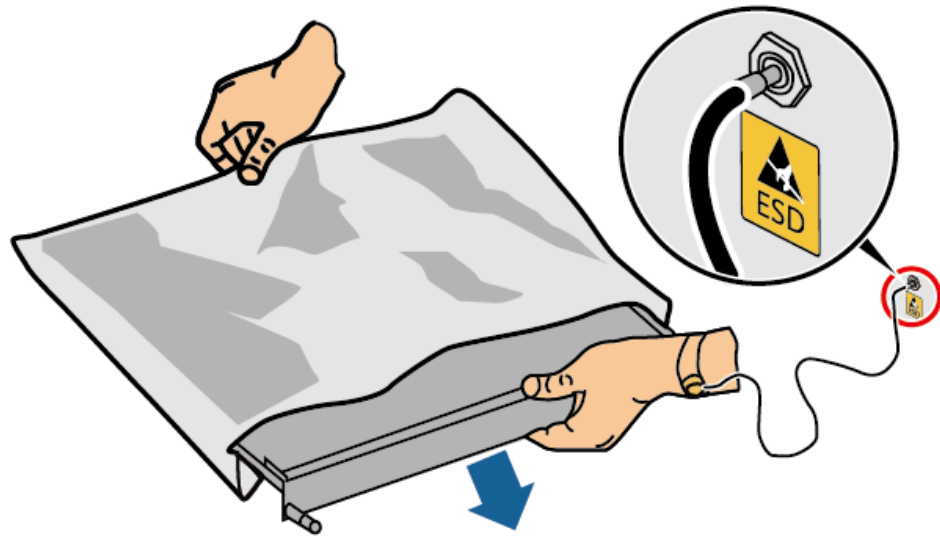

DC15000001

- When holding a board or a module with exposed circuit boards, hold its edge without touching any components. Do not touch the components with bare hands.
- Package boards or modules with ESD packaging materials before storing or transporting them.

1.3 Environment Requirements

⚠ DANGER

Do not expose the equipment to flammable or explosive gas or smoke. Do not perform any operation on the equipment in such environments.

⚠ DANGER

Do not store any flammable or explosive materials in the equipment area.

⚠ DANGER

Do not place the equipment near heat sources or fire sources, such as smoke, candles, heaters, or other heating devices. Overheat may damage the equipment or cause a fire.

 **WARNING**

Install the equipment in an area far away from liquids. Do not install it under areas prone to condensation, such as under water pipes and air exhaust vents, or areas prone to water leakage, such as air conditioner vents, ventilation vents, or feeder windows of the equipment room. Ensure that no liquid enters the equipment to prevent faults or short circuits.

 **WARNING**

To prevent damage or fire due to high temperature, ensure that the ventilation vents or heat dissipation systems are not obstructed or covered by other objects while the equipment is running.

General Requirements

- Ensure that the equipment is stored in a clean, dry, and well ventilated area with proper temperature and humidity and is protected from dust and condensation.
- Keep the installation and operating environments of the equipment within the allowed ranges. Otherwise, its performance and safety will be compromised.
- Do not install, use, or operate outdoor equipment and cables (including but not limited to moving equipment, operating equipment and cables, inserting connectors to or removing connectors from signal ports connected to outdoor facilities, working at heights, performing outdoor installation, and opening doors) in harsh weather conditions such as lightning, rain, snow, and level 6 or stronger wind.
- Do not install the equipment in an environment with direct sunlight, dust, smoke, volatile or corrosive gases, infrared and other radiations, organic solvents, or salty air.
- Do not install the equipment in an environment with conductive metal or magnetic dust.
- Do not install the equipment in an area conducive to the growth of microorganisms such as fungus or mildew.
- Do not install the equipment in an area with strong vibration, noise, or electromagnetic interference.
- Ensure that the site complies with local laws, regulations, and related standards.
- Ensure that the ground in the installation environment is solid, free from spongy or soft soil, and not prone to subsidence. The site must not be located in a low-lying land prone to water or snow accumulation, and the horizontal level of the site must be above the highest water level of that area in history.
- Do not install the equipment in a position that may be submerged in water.
- If the equipment is installed in a place with abundant vegetation, in addition to routine weeding, harden the ground underneath the equipment using cement or gravel (the area shall be greater than or equal to 3 m x 2.5 m).
- Do not install the equipment outdoors in salt-affected areas because it may be corroded. A salt-affected area refers to the region within 500 m of the

coast or prone to sea breeze. Regions prone to sea breeze vary with weather conditions (such as typhoons and monsoons) or terrains (such as dams and hills).

- Before installation, operation, and maintenance, clean up any water, ice, snow, or other foreign objects on the top of the equipment.
- When installing the equipment, ensure that the installation surface is solid enough to bear the weight of the equipment.
- All cable holes must be sealed. Seal the used cable holes with sealing putty. Seal the unused cable holes with the caps delivered with the equipment. The following figure shows the criteria for correct sealing with sealing putty.

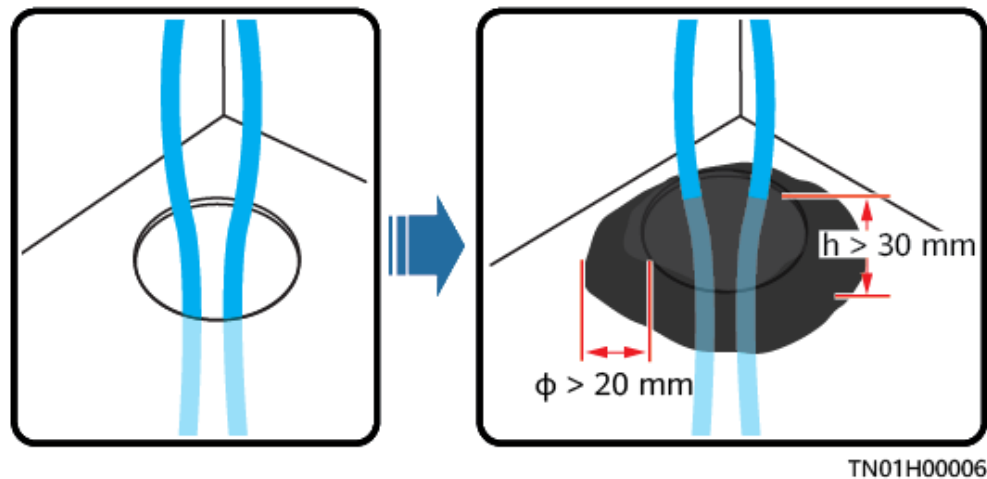

- After installing the equipment, remove the packing materials such as cartons, foam, plastics, and cable ties from the equipment area.

1.4 Mechanical Safety

DANGER

When working at heights, wear a safety helmet and safety harness or waist belt and fasten it to a solid structure. Do not mount it on an insecure moveable object or metal object with sharp edges. Make sure that the hooks will not slide off.

WARNING

Ensure that all necessary tools are ready and inspected by a professional organization. Do not use tools that have signs of scratches or fail to pass the inspection or whose inspection validity period has expired. Ensure that the tools are secure and not overloaded.

 **WARNING**

Do not drill holes into the equipment. Doing so may affect the sealing performance and electromagnetic containment of the equipment and damage components or cables inside. Metal shavings from drilling may short-circuit boards inside the equipment.

General Requirements

- Repaint any paint scratches caused during equipment transportation or installation in a timely manner. Equipment with scratches must not be exposed for an extended period of time.
- Do not perform operations such as arc welding and cutting on the equipment without evaluation by the Company.
- Do not install other devices on the top of the equipment without evaluation by the Company.
- When performing operations over the top of the equipment, take measures to protect the equipment against damage.
- Use correct tools and operate them in the correct way.

Moving Heavy Objects

- Be cautious to prevent injury when moving heavy objects.



< 18 kg
(< 40 lbs)



18–32 kg
(40–70 lbs)



32–55 kg
(70–121 lbs)

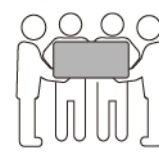

55–68 kg
(121–150 lbs)



> 68 kg
(> 150 lbs)

CZ0000110

- If multiple persons need to move a heavy object together, determine the manpower and work division with consideration of height and other conditions to ensure that the weight is equally distributed.
- If two persons or more move a heavy object together, ensure that the object is lifted and landed simultaneously and moved at a uniform pace under the supervision of one person.
- Wear personal protective gears such as protective gloves and shoes when manually moving the equipment.
- To move an object by hand, approach to the object, squat down, and then lift the object gently and stably by the force of the legs instead of your back. Do not lift it suddenly or turn your body around.
- Do not quickly lift a heavy object above your waist. Place the object on a workbench that is half-waist high or any other appropriate place, adjust the positions of your palms, and then lift it.
- Move a heavy object stably with balanced force at an even and low speed. Put down the object stably and slowly to prevent any collision or drop from scratching the surface of the equipment or damaging the components and cables.

- When moving a heavy object, be aware of the workbench, slope, staircase, and slippery places. When moving a heavy object through a door, ensure that the door is wide enough to move the object and avoid bumping or injury.
- When transferring a heavy object, move your feet instead of turning your waist around. When lifting and transferring a heavy object, ensure that your feet point to the target direction of movement.
- When transporting the equipment using a pallet truck or forklift, ensure that the tynes are properly positioned so that the equipment does not topple. Before moving the equipment, secure it to the pallet truck or forklift using ropes. When moving the equipment, assign dedicated personnel to take care of it.
- Choose sea or roads in good conditions for transportation. Do not transport the equipment by railway or air. Avoid tilt or jolt during transportation.

Working at Heights

- Any operations performed 2 m or higher above the ground shall be supervised properly.
- Only trained and qualified personnel are allowed to work at heights.
- Do not work at heights when steel pipes are wet or other risky situations exist. After the preceding conditions no longer exist, the safety owner and relevant technical personnel need to check the involved equipment. Operators can begin working only after safety is confirmed.
- Set a restricted area and prominent signs for working at heights to warn away irrelevant personnel.
- Set guard rails and warning signs at the edges and openings of the area involving working at heights to prevent falls.
- Do not pile up scaffolding, springboards, or other objects on the ground under the area involving working at heights. Do not allow people to stay or pass under the area involving working at heights.
- Carry operation machines and tools properly to prevent equipment damage or personal injury caused by falling objects.
- Personnel involving working at heights are not allowed to throw objects from the height to the ground, or vice versa. Objects shall be transported by slings, hanging baskets, aerial work platforms, or cranes.
- Do not perform operations on the upper and lower layers at the same time. If unavoidable, install a dedicated protective shelter between the upper and lower layers or take other protective measures. Do not pile up tools or materials on the upper layer.
- Dismantle the scaffolding from top down after finishing the job. Do not dismantle the upper and lower layers at the same time. When removing a part, ensure that other parts will not collapse.
- Ensure that personnel working at heights strictly comply with the safety regulations. The Company is not responsible for any accident caused by violation of the safety regulations on working at heights.
- Behave cautiously when working at heights. Do not rest at heights.

Using Ladders

- Use wooden or insulated ladders when you need to perform live-line working at heights.
- Platform ladders with protective rails are preferred. Single ladders are not recommended.
- Before using a ladder, check that it is intact and confirm its load bearing capacity. Do not overload it.
- Ensure that the ladder is securely positioned and held firm.



CZ00000107

- When climbing up the ladder, keep your body stable and your center of gravity between the side rails, and do not overreach to the sides.
- When a step ladder is used, ensure that the pull ropes are secured.
- If a single ladder is used, the recommended angle for the ladder against the floor is 75 degrees, as shown in the following figure. A square can be used to measure the angle.

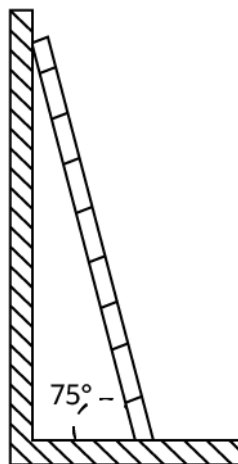

PI025C0008

- If a single ladder is used, ensure that the wider end of the ladder is at the bottom, and take protective measures to prevent the ladder from sliding.
- If a single ladder is used, do not climb higher than the fourth rung of the ladder from the top.
- If you use a single ladder to climb up to a platform, ensure that the ladder is at least 1 m higher than the platform.

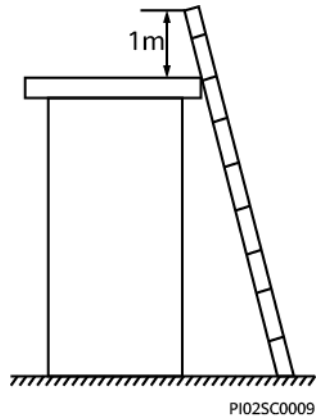

Drilling Holes

- Obtain consent from the customer and contractor before drilling holes.
- Wear protective equipment such as safety goggles and protective gloves when drilling holes.
- To avoid short circuits or other risks, do not drill holes into buried pipes or cables.
- When drilling holes, protect the equipment from shavings. After drilling, clean up any shavings.

2 Product Description

2.1 Model Number Description

This document involves the following product model:

EMMA-A02

Figure 2-1 Model number



Table 2-1 Model number description

No.	Item	Description
1	Product family name	EMMA is a smart home energy controller. It has been renamed SmartAssistant.
2	Hardware ID	A: hardware platform version
3	Configuration ID	02: Features of PV devices, energy storage systems (ESSs), smart chargers, and smart loads are supported.

2.2 Networking

The SmartAssistant is a device that manages energy in a home with a PV system. It can implement unified scheduling and management of home energy.

Features of PV devices, ESSs, smart chargers, and smart loads are supported. In addition to unified scheduling of home energy, the SmartAssistant **can connect to appliances such as Huawei chargers, SG Ready heat pumps, smart switches,**

and other smart loads. Users can set the reservation time to charge vehicles and heat water in advance at the specified time. In addition, users can set the priority to use PV energy for devices as required to make the best use of PV energy.

NOTE

- The SmartAssistant supports load consumption optimization and negative rate optimization.
- The built-in power measurement module of the SmartAssistant is used to control the power at the grid connection point. The measurement data cannot be used as the basis for electricity billing, which is subject to the metering by the power grid company.

Figure 2-2 Networking diagram

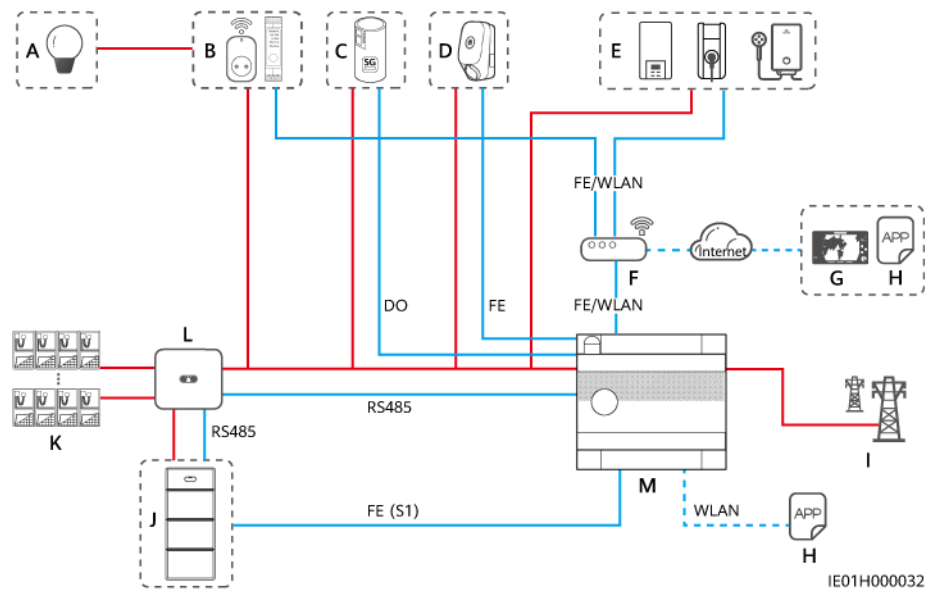

- | | | |
|--|-----------------------|------------------------|
| (A) Power load | (B) Smart switch | (C) SG Ready heat pump |
| (D) Huawei charger | (E) Other smart loads | (F) Router |
| (G) FusionSolar Smart PV Management System (SmartPVMS) | (H) FusionSolar app | (I) Power grid |
| (J) ESS | (K) PV string | (L) Inverter |
| (M) SmartAssistant | | |

The networking is described as follows:

- A maximum of 40 devices can be connected to the SmartAssistant.
- Inverters connect to the SmartAssistant over RS485. A maximum of three inverters can be connected in parallel and a maximum of 12 ESSs can be connected.

- The SmartAssistant is connected to the router over FE or WLAN.
- The LAN port can be used to connect one Huawei charger or one ESS to the SmartAssistant over FE.
- A maximum of two chargers can be connected.
 - If there is only one Huawei charger, it can be directly connected to the SmartAssistant over FE or connected to the router over FE or WLAN.
 - If there is one third-party charger, connect it to the router over FE or WLAN.
 - If there are two Huawei chargers, they must be connected to the router only over FE or WLAN. Do not connect one charger to the SmartAssistant and the other charger to the router at the same time.
 - If there is one Huawei charger and one third-party charger, connect the Huawei charger directly to the SmartAssistant over FE or to the router over FE or WLAN. Connect the third-party charger to the router over FE or WLAN.
- The SmartAssistant directly controls the SG Ready heat pump through dry contacts or an external relay.
- Connect smart switches and other smart loads to the router over FE or WLAN. A maximum of 20 smart switches can be connected. Number of third-party smart loads that can be connected: one third-party charger, one EEBUS heat pump, and one heating rod.
- For third-party devices that are not adapted to the system, system commissioning and adaptation are required. If the adaptation is not completed, the devices may fail to be installed and used onsite. For details about the third-party devices that have passed the interconnection test, see, see *SmartAssistant and Smart Appliance Compatibility Test List..* **Note: The manufacturer and seller are responsible for the quality, safety, and related services of the third-party devices.**

NOTICE

For details about the mapping in the SmartAssistant network, see [Residential Smart PV Solution User Manual \(SmartAssistant Networking and SmartGuard Networking\)](#).

2.3 Appearance

Appearance and Ports

Figure 2-3 Appearance description

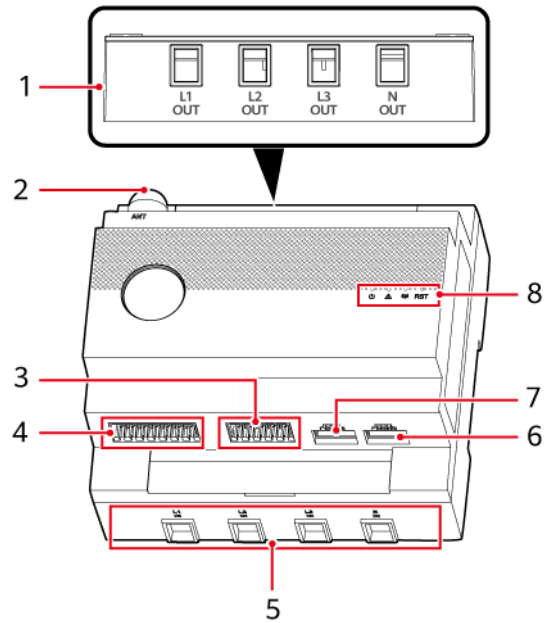

IE01H000003

(1) AC output port (L1 OUT/L2 OUT/L3 OUT/N OUT)

(2) External WLAN antenna port (ANT)

(3) 12 V input/RS485 communication/external CT input port (12V_IN/RS485/CT Input)

(4) RS485 communication/DI/12 V output/DO port (RS485/DI/12V_OUT/DO)

(5) AC input port (L1 IN/L2 IN/L3 IN/N IN)



(6) WAN port (WAN)

(7) LAN port (LAN)

(8) LED indicator/RST button

Indicator Description

Table 2-2 LED indicator description

Indicator	Status	Description
Running status indicator 	Off	The device is not powered on.
	Steady green	The device is powered on and running.
Alarm indicator 	Off	No alarm is raised.
	Blinking red slowly (on for 1s and then off for 4s)	A warning or minor alarm is generated.
	Blinking red fast (on for 0.5s and then off for 0.5s)	A major alarm is generated.
	Steady red	A critical alarm is generated.
Communication status indicator 	Off	The device has no communication with the management system.
	Blinking green slowly (on for 1s and then off for 1s)	The communication between the device and the management system is normal.
	Blinking green fast (on for 0.125s and then off for 0.125s)	The communication between the device and the management system is interrupted.

Button Description



Appearance	Definition	Triggering Method	Description
	WiFi module hibernation and wakeup	Hold down the button for 1s to 3s.	When the WiFi access point (AP) is idle and disabled, you can hold down the button for 1s to 3s to wake up the WiFi AP.
	Human-machine account password restoration	Hold down the button for 10s to 60s.	<ul style="list-style-type: none"> Restore the login passwords of the human-machine accounts, such as local installer and user accounts to the initial passwords. Reset the login password of the local WiFi AP.

Appearance	Definition	Triggering Method	Description
	Factory settings restoration	Hold down the button for more than 60s.	The SmartAssistant restarts and restores factory settings. NOTICE All data except communication networking parameters, historical alarms, and performance data will be restored to factory settings. Exercise caution when performing this operation.

2.4 Label Description

Enclosure Labels

Table 2-3 Enclosure labels

Symbol	Name	Meaning
	High voltage warning label	Be careful of electric shocks at high voltage.
SN:XXXXXXXXXX REGKEY:XXXXXXXX SSID:XXXXXXXXXX PSW:XXXXXXX	Device information	<ul style="list-style-type: none"> • SN: serial number. • REGKEY: registration code for registering the FusionSolar Smart PV Management System (SmartPVMS) on the app. • SSID: WLAN hotspot name. • PSW: password for logging in to the WLAN.
	EMMA Pro	Unique identifier of the SmartAssistant, indicating that the SmartAssistant supports the features of smart chargers and smart loads in addition to PV and ESS features.
	QR code	Scan the QR code to connect to the SmartAssistant WLAN and securely access the FusionSolar SmartPVMS.

Product Nameplate

The following figure shows the position of the nameplate, including the trademark, product model, key technical specifications, compliance symbols, company name, and place of origin.

Figure 2-4 Position of the nameplate

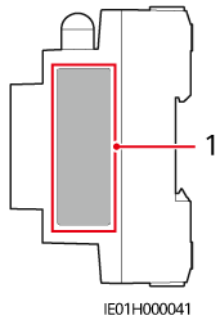

(1) Position of the nameplate

3 Storage Requirements

If the SmartAssistant is not used immediately, store it according to the following requirements:

- Do not remove the packaging. Check the packaging regularly (once every three months recommended). Replace any packaging that is damaged during storage. If the SmartAssistant is unpacked but not put into use immediately, place it inside the original package with the desiccant bag, and seal it using tape.
- Store the device at the temperature range of -40°C to $+85^{\circ}\text{C}$ and relative humidity range of 5% to 95% without condensing. The air must not contain corrosive or flammable gases.
- Store the device in a clean and dry place and protect it from dust and moisture. The device must be protected against rain and water.
- If the SmartAssistant has been stored for more than two years, it must be checked and tested by professionals before use.

4 Installation



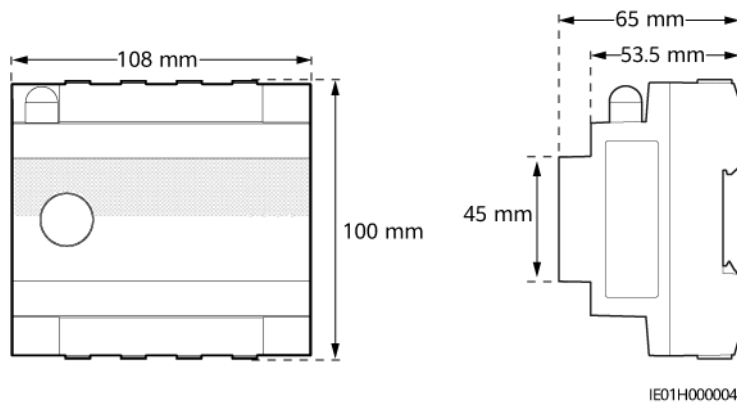

4.1 Installation Requirements

Figure 4-1 Installation requirements



4.2 Preparing Tools

Table 4-1 Personal protective equipment (PPE)

			
Safety helmet	Goggles	Reflective vest	Insulated shoes











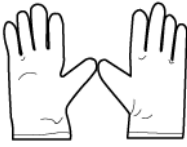

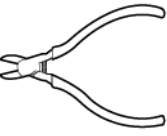
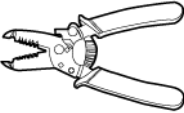
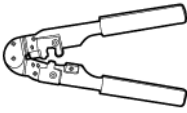

 <p>Electrostatic discharge (ESD) gloves</p>	 <p>Insulated gloves</p>	 <p>Protective gloves</p>	 <p>Dust mask</p>
---	---	---	--

Table 4-2 Installation tools

 <p>Cable cutter</p>	 <p>Diagonal pliers</p>	 <p>Wire stripper</p>	 <p>RJ45 crimping tool</p>
  <p>Flat-head insulated torque screwdriver</p>	  <p>Phillips insulated torque screwdriver</p>	 <p>Utility knife</p>	 <p>Marker</p>
 <p>Steel measuring tape</p>	 <p>Cable tie</p>	 <p>Multimeter</p>	 <p>Eject pin</p>

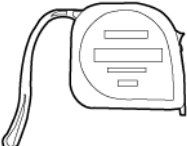
4.3 Checking Before the Installation

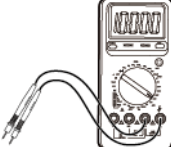
Figure 4-2 Packing list

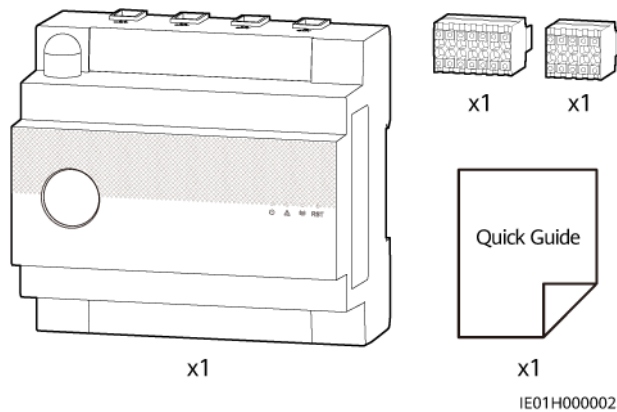

Check Item	Check Criteria
Outer package	Before unpacking the product, check the outer packaging for damage, such as holes and cracks, and check the product model. If any damage is found or the model is not what you requested, do not unpack the product and contact your vendor as soon as possible.
Deliverable	Check the number of deliverables according to the packing list and check whether there is any obvious external damage. If any part is missing or damaged, contact your vendor.

4.4 Installing the SmartAssistant

Context

Install the SmartAssistant on the DIN 35 mm standard guide rail of the AC power distribution box in which a surge protective device must be configured.

Procedure

- Step 1** Clamp the SmartAssistant onto the DIN 35 mm standard guide rail from bottom to top, and push the SmartAssistant upwards.
- Step 2** Fasten the SmartAssistant to the guide rail.

Figure 4-3 Installing the SmartAssistant

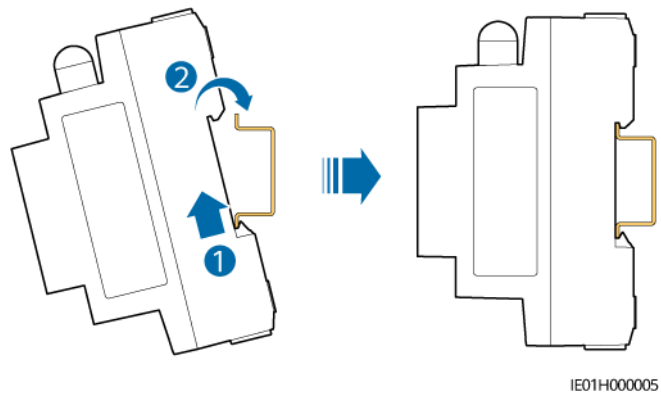

----End

5 Electrical Connections

DANGER

- The site must be equipped with qualified fire fighting facilities, such as fire sand and carbon dioxide fire extinguishers.
 - Wear PPE and use dedicated insulated tools to avoid electric shocks or short circuits.
-

WARNING

- Equipment damage caused by incorrect cable connections is not covered by the product warranty.
 - Only certified electricians are allowed to connect cables.
 - Operation personnel must wear PPE when connecting cables.
 - Before connecting cables to ports, leave enough slack to reduce the tension on the cables and prevent poor cable connections.
-

CAUTION

- Stay away from the equipment when preparing cables to prevent cable scraps from entering the equipment. Cable scraps may cause sparks and result in personal injury and equipment damage.
 - When laying out a signal cable, separate it from power cables and keep it away from strong interference sources to prevent communication interruption.
-

NOTE

The cable colors shown in cable connection schematic diagrams are for reference only. Select cables according to local cable specifications.

5.1 Preparing Cables

NOTICE

- When laying out a signal cable, separate it from power cables and keep it away from strong interference sources to prevent communication interruption.
- The minimum cable cross-sectional area must meet local standards.
- The factors that affect cable selection include the rated current, cable type, routing mode, ambient temperature, and maximum expected line loss.

Figure 5-1 Cable connection diagram: internal CT connection (current ≤ 63 A)

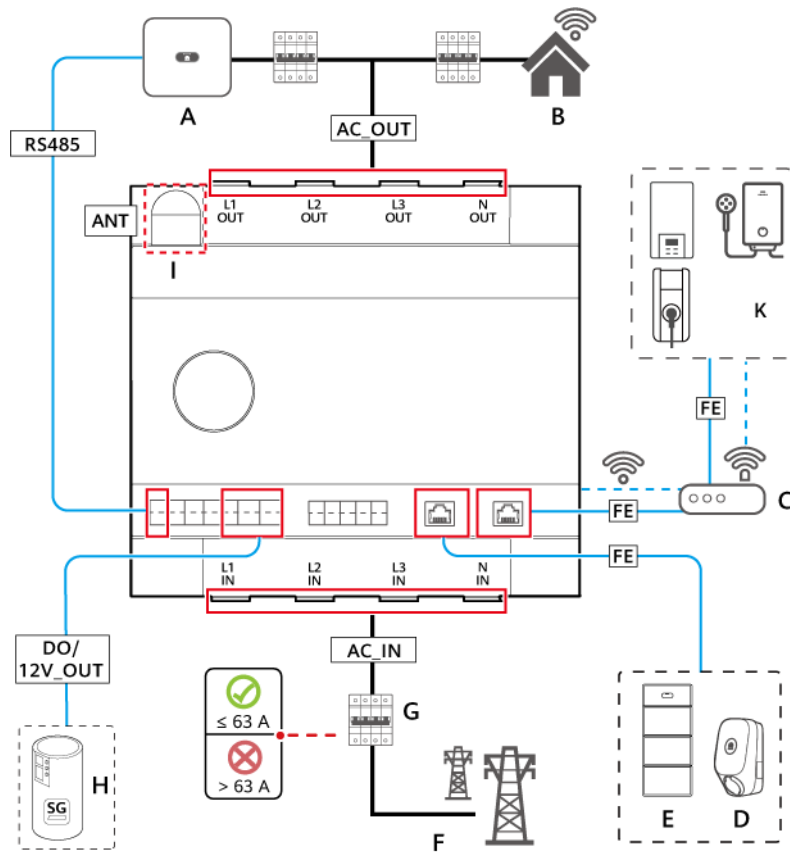

IE01H00007

Figure 5-2 Cable connection diagram: external CT connection (current > 63 A)

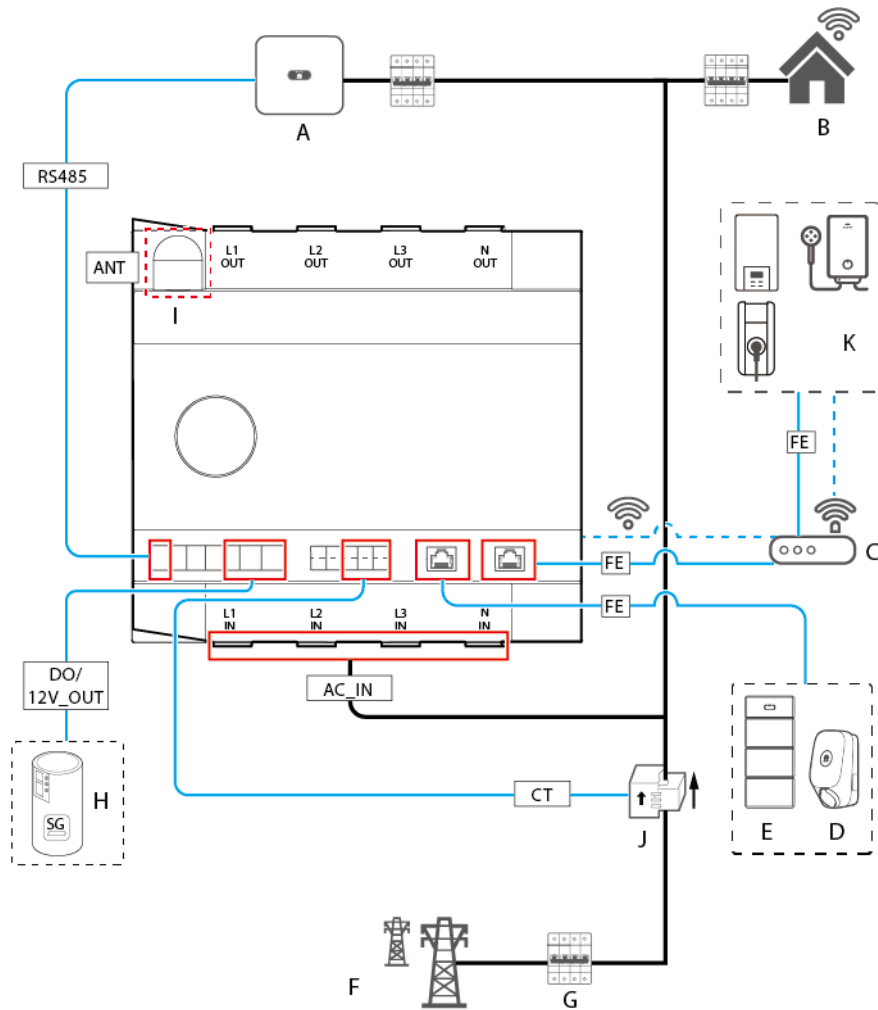

S000739

- | | | |
|--------------------------|------------------------|---------------------------|
| (A) Inverter | (B) Residential load | (C) Router |
| (D) Huawei charger | (E) ESS (S1) | (F) Power grid |
| (G) Main circuit breaker | (H) SG Ready heat pump | (I) External WLAN antenna |
| (J) External CT | (K) Other smart loads | |

NOTE

A maximum of 40 devices can be connected to the SmartAssistant.

Table 5-1 Recommended cable specifications

Item	Name	Type	Conductor Cross-Sectional Area	Source
AC_IN AC_OUT	AC input power cable AC output power cable	Outdoor copper cable (temperature resistance $\geq 90^{\circ}\text{C}$)	<ul style="list-style-type: none"> Internal CT connection: 16 mm² External CT connection: 6 mm² to 16 mm² 	Prepared by the customer
RS485	RS485 communications cable	Two-core outdoor shielded twisted pair cable	0.2 mm ² to 1.5 mm ² (0.5 mm ² recommended)	Prepared by the customer
CT	(Optional) External CT cable	Two-core or multi-core twisted pair cable	0.2 mm ² to 1.5 mm ² (0.5 mm ² recommended)	Prepared by the customer
DO	DO signal cable	Two-core or multi-core twisted pair cable	0.2 mm ² to 1.5 mm ² (0.5 mm ² recommended)	Prepared by the customer
12V_OUT	12 V output cable	Two-core or multi-core twisted pair cable	0.2 mm ² to 1.5 mm ² (0.5 mm ² recommended)	Prepared by the customer
FE	FE communications cable	Cat 5e network cable, internal resistance ≤ 1.5 ohms/10 m RJ45 connector	0.12 mm ² to 0.2 mm ² (0.2 mm ² recommended)	Prepared by the customer
ANT	(Optional) External WLAN antenna	External antenna with the RP-SMA-J port	-	Purchased from Huawei

Table 5-2 Recommended external CT specifications

Turn Ratio	Accuracy	Test Point	Percentage at Rated Current				
			1%	5%	20%	100%	120%
$\geq 2000 : 1$	0.2	Ratio difference (%)	± 0.40	± 0.20	± 0.20	± 0.20	± 0.20

Turn Ratio	Accuracy	Test Point	Percentage at Rated Current				
			1%	5%	20%	100%	120%
		Angle difference (')	±30	±15	±10	±10	±10
NOTE <ul style="list-style-type: none"> • Secondary side: 50 mA • Primary side: $N \times 50$ A ($N \geq 2$, and N is an integer) • The external CT communications cables are shorter than or equal to 30 m and not routed separately. It is recommended that the cables be routed through pipes. 							

Table 5-3 Recommended external WLAN antenna specifications

Item	Specifications
Frequency range	2400–2500 MHz
Gain	2.5–4 dBi
Direction	Omnidirectional
Voltage standing wave ratio (VSWR)	≤ 2
Polarization	Linear polarization
Efficiency	$\geq 30\%$
Maximum input power	1 W
Impedance	50 Ω
Connector	RP-SMA-J
Operating temperature	-40°C to +85°C
Operating humidity	5%–95% RH

5.2 Connecting the AC Power Cable or External CT Cable

The SmartAssistant supports internal CT connection (current ≤ 63 A) or external CT connection (current > 63 A).

Context

Figure 5-3 AC input power cable ports

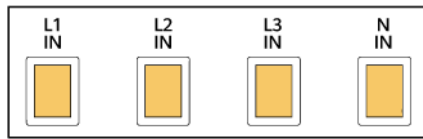

IE01H000013

Port	Pin	Function	Description
AC-IN	L1-IN	AC input power cable L1	Connect to the power grid.
	L2-IN	AC input power cable L2	
	L3-IN	AC input power cable L3	
	N-IN	AC input power cable N	

Figure 5-4 AC output power cable ports

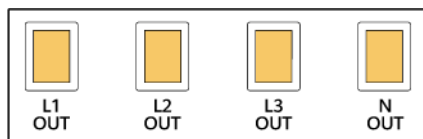

IE01H000014

Port	Pin	Function	Description
AC-OUT	L1-OUT	AC output power cable L1	Supply power to loads in internal CT connection mode.
	L2-OUT	AC output power cable L2	
	L3-OUT	AC output power cable L3	
	N-OUT	AC output power cable N	

Figure 5-5 10-pin connector

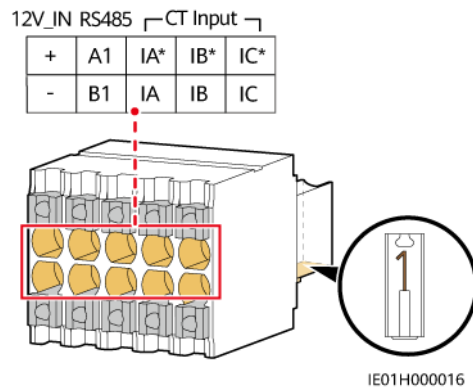

Port	Pin	Function	Description
12V_IN	+	12 V power input+	Used only in the SmartGuard scenario for the whole-house power backup. The SmartGuard provides 12 V DC power for the SmartAssistant when the SmartAssistant is in offline mode.
	-	12 V power input-	
RS485	A1	RS485A, RS485 differential signal+	Used to connect to the SmartGuard.
	B1	RS485B, RS485 differential signal-	
CT Input	IA*	External CT input phase A+	Used to connect to an external CT.
	IA	External CT input phase A-	
	IB*	External CT input phase B+	
	IB	External CT input phase B-	
	IC*	External CT input phase C+	
	IC	External CT input phase C-	

Procedure

Step 1 Prepare cord end terminals for AC power cables and determine whether to prepare external CT cables as needed.

1. You are advised to prepare cord end terminals for AC power cables.

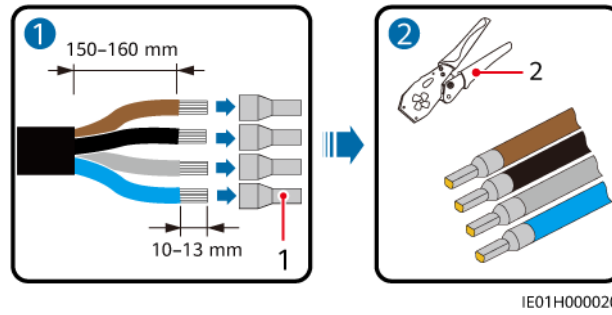

(1) Cord end terminal

(2) Crimping tool

2. (Optional) For the external CT connection, connect the external CT cables to the 10-pin signal connector.

Figure 5-6 Connecting the external CT cables to the 10-pin connector

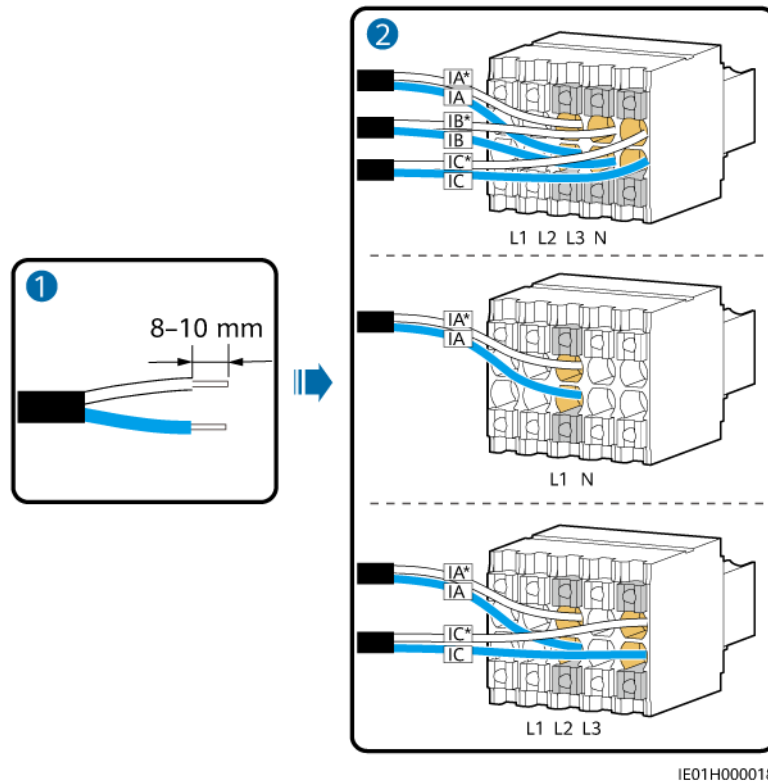

- Step 2** Open the protective cover of the cable fixing screw, insert the AC power cable into the AC input port, and tighten the screw.

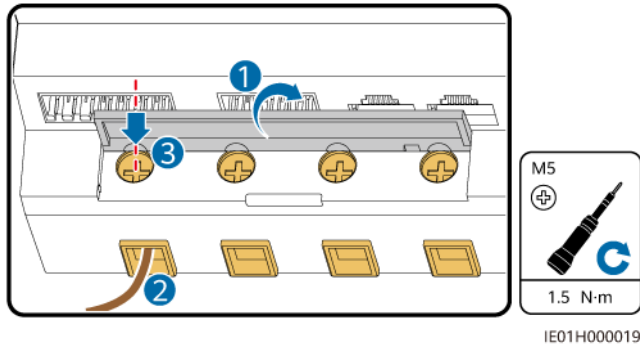

Step 3 Connect all AC power cables and external CT cables based on the power grid connection.

Figure 5-7 Internal CT connection (current ≤ 63 A)

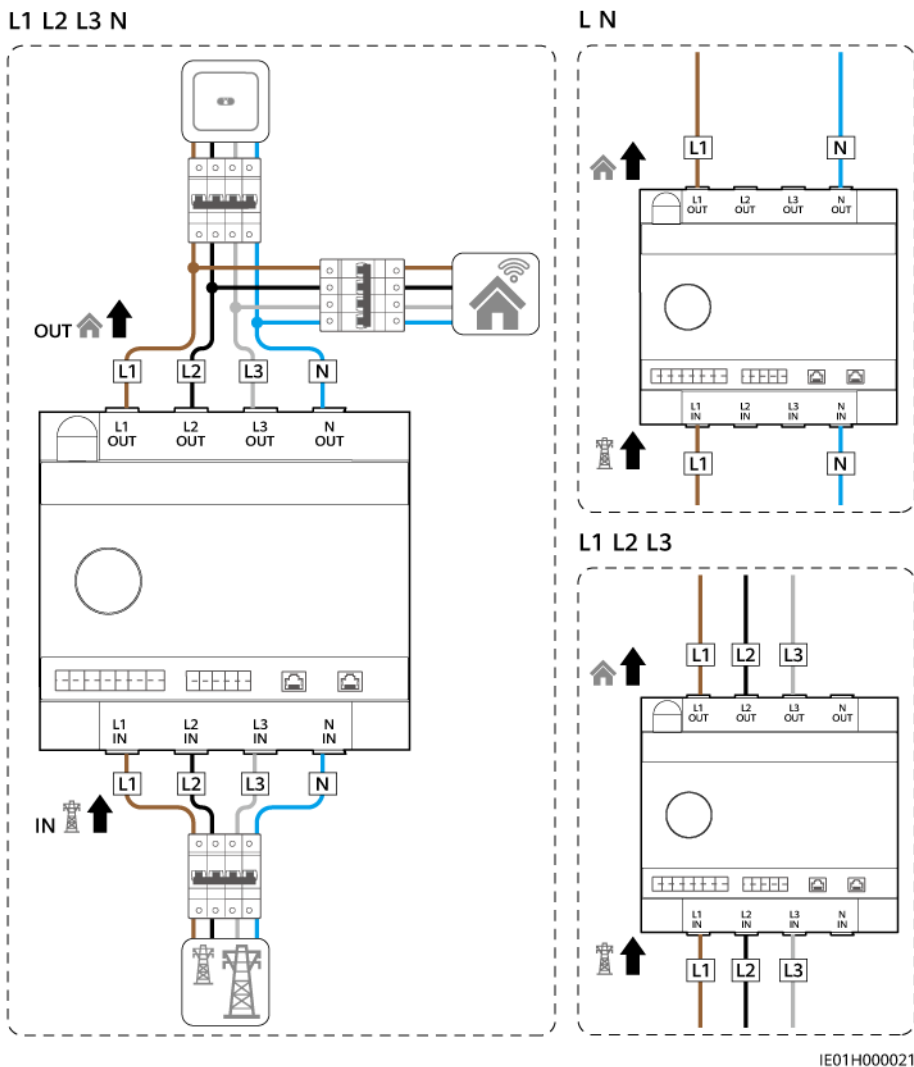

NOTE

In the single-phase cable connection scenario (L N), you are advised to connect cables to the L1 and N terminals on the SmartAssistant.

5.3 Connecting RS485 Communications Cables, DO Signal Cables, and 12 V Output Cables

Context

Figure 5-9 14-pin connector

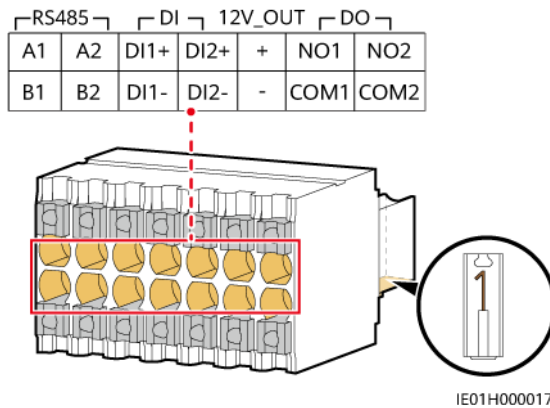

Port	Pin	Function	Description
RS485	RS485A1	RS485A, RS485 differential signal+	Connect to the inverter.
	RS485B1	RS485B, RS485 differential signal-	
	RS485A2	RS485A, RS485 differential signal+	<ul style="list-style-type: none"> Connect to the RS485 port of the power meter if some of loads are connected to the SmartGuard. Reserved for connecting to a third-party device.
	RS485B2	RS485B, RS485 differential signal-	
DI	DI1+	Digital input signal 1+	Connect to the ATS port for the position feedback signal upon grid connection in the SmartGuard scenario.
	DI1-	Digital input signal 1-	
	DI2+	Digital input signal 2+	Connect to the generator alarm signal port in the SmartGuard scenario.
	DI2-	Digital input signal 2-	
12V_OUT	+	12 V power output+	<ul style="list-style-type: none"> The rated output power capability is 12 V@100 mA, and the output voltage ranges from 9.5 V to 13.2 V. The port is used to help the DO control the heat pump.
	-	12 V power output-	

Port	Pin	Function	Description
DO	NO1	Normally open contact for digital output signal 1	<ul style="list-style-type: none"> The DO port has two types of dry contacts. The DO contact capacity is 12 V DC@1 A. The NO and COM contacts are normally open. NO1/COM1 is used to control the heat pump, and NO2/COM2 is reserved.
	COM1	Common contact for digital output signal 1	
	NO2	Normally open contact for digital output signal 2	
	COM2	Common contact for digital output signal 2	

Procedure

Step 1 Connect the RS485 communications cable to the 14-pin connector.

Figure 5-10 Connecting RS485 communications cables

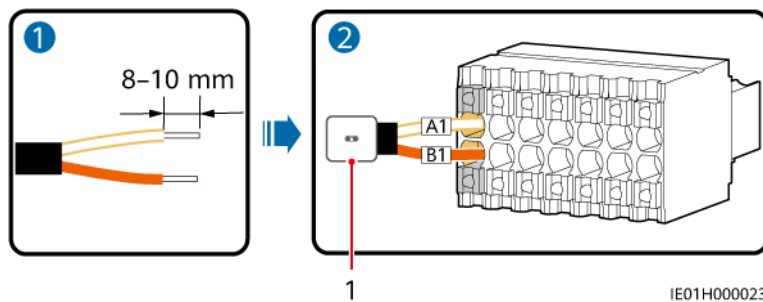

(1) Inverter

Step 2 Connect the DO signal cable or 12 V output cable to the 14-pin connector.

The SmartAssistant can be connected to the SG Ready heat pump through the DO signal cable or 12 V output cable. The SmartAssistant provides two control modes based on the SG Ready heat pump port.

- Mode 1: Use a 12 V@100 mA power supply to drive the external relay. Choose the proper contact capability of the external relay according to the SG Ready heat pump port.

Figure 5-11 Connecting the power DO to the SG Ready heat pump

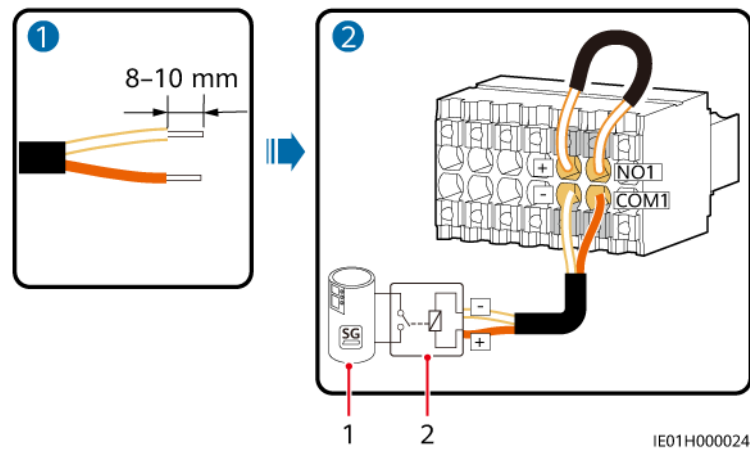

(1) SG Ready heat pump

(2) External relay

- Mode 2: Use DO dry contacts to directly drive the SG Ready heat pump. The capacity of the DO dry contacts is 12 V DC@1 A.

Figure 5-12 Connecting the signal DO to the SG Ready heat pump

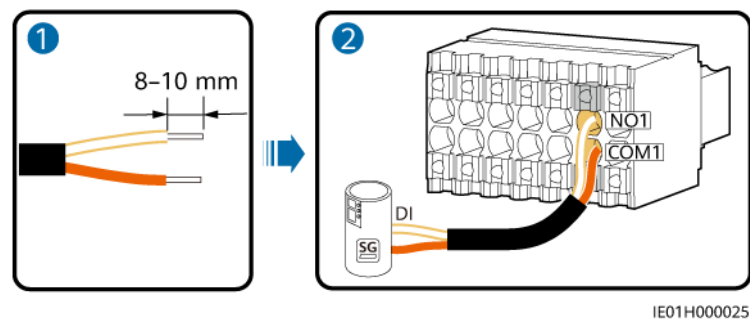

Step 3 Insert the 14-pin signal connector into the SmartAssistant.

Figure 5-13 Installing a 14-pin signal connector

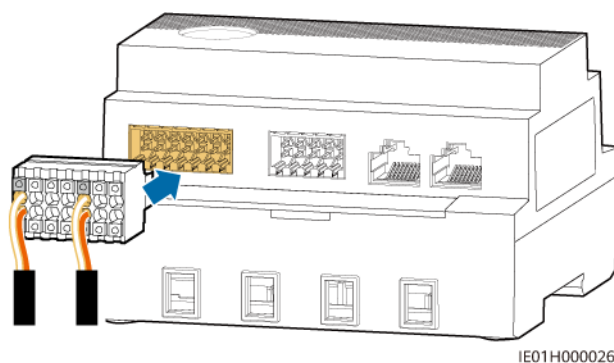

----End

5.4 Installing FE Communications Cables

Context

Table 5-4 FE communications port

Port	Function	Description
LAN	RJ45 network port	Connects to a Huawei charger or an ESS.
WAN	RJ45 network port	Connects to a router.

Procedure

Step 1 Connect the FE communications cables.

Figure 5-14 Connecting FE communications cables

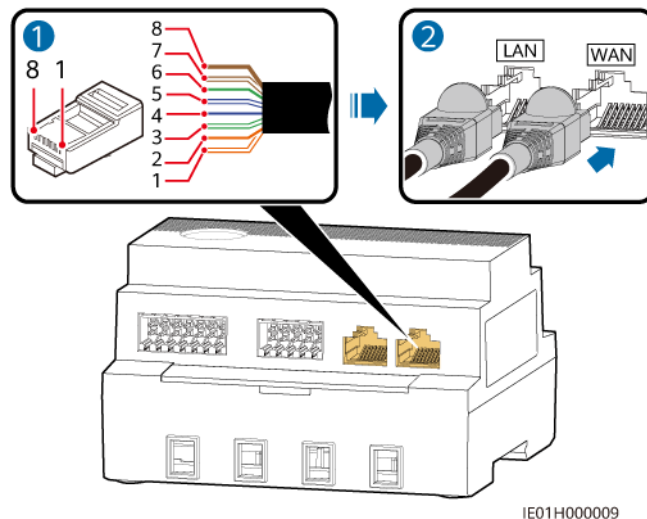

IE01H000009

- (1) White-and-orange (2) Orange (3) White-and-green (4) Blue
(5) White-and-blue (6) Green (7) White-and-brown (8) Brown

----End

5.5 (Optional) Installing External WLAN Antennas

The SmartAssistant can connect to a WLAN built-in antenna by default. If the signal quality of the power distribution box is poor, an external antenna with the RP-SMA-J port can be configured to enhance the signal quality.

Procedure

Step 1 Remove the dustproof cap from the ANT port.

Step 2 Install the external WLAN antenna.

Figure 5-15 Installing a WLAN antenna

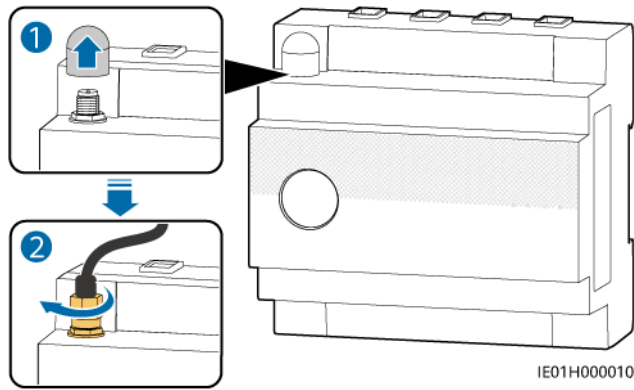

Step 3 Select an appropriate position and attach the external antenna by magnet.

Figure 5-16 Securing the external antenna

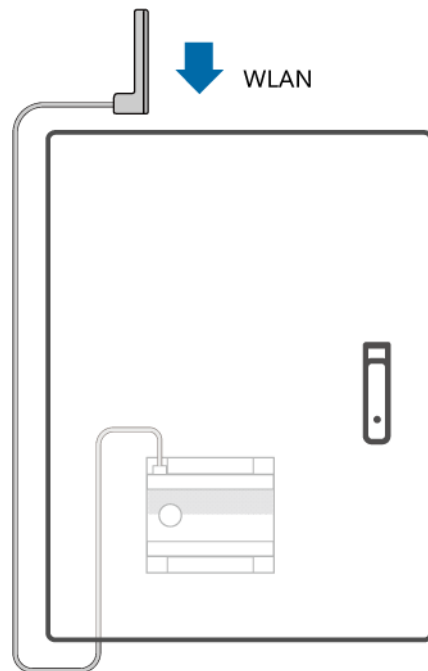

----End

6 Power-On and Commissioning

DANGER

- Wear personal protective equipment and use dedicated insulated tools to avoid electric shocks or short circuits.

NOTICE

Before the equipment is put into operation for the first time, ensure that the parameters are set correctly by professional personnel. Incorrect parameter settings may result in noncompliance with local grid connection requirements and affect the normal operations of the equipment.

6.1 Check Before Power-On

No.	Expected Result
1	The SmartAssistant is installed correctly and securely.
2	All cables are connected securely.
3	Power cables and signal cables are routed according to the requirements for routing electrical and ELV cables and in compliance with the cable routing plan.
4	Cables are bound neatly, and cable ties are secured evenly and properly in the same direction.
5	There are no unnecessary adhesive tapes or cable ties on cables.

6.2 Powering On the SmartAssistant

DANGER

- Wear personal protective equipment and use dedicated insulated tools to avoid electric shocks or short circuits.



NOTICE

Before the equipment is put into operation for the first time, ensure that the parameters are set correctly by professional personnel. Incorrect parameter settings may result in noncompliance with local grid connection requirements and affect the normal operations of the equipment.

Procedure

- Step 1** Turn on the main circuit breaker between the SmartAssistant and the grid.
- Step 2** Turn on the AC switch between the SmartAssistant and the inverter.
- Step 3** Observe the LED indicators on the SmartAssistant to check its running status.

Table 6-1 LED indicator description

Indicator	Status	Description
	Off	The device is not powered on.
	Steady green	The device is powered on and running.
	Off	No alarm is raised.
	Blinking red slowly (on for 1s and then off for 4s)	A warning or minor alarm is generated.
	Blinking red fast (on for 0.5s and then off for 0.5s)	A major alarm is generated.
	Steady red	A critical alarm is generated.

Indicator	Status	Description
Communication status indicator 	Off	The device has no communication with the management system.
	Blinking green slowly (on for 1s and then off for 1s)	The communication between the device and the management system is normal.
	Blinking green fast (on for 0.125s and then off for 0.125s)	The communication between the device and the management system is interrupted.

----End

6.3 Commissioning the SmartAssistant

6.3.1 Deploying a New Plant

Figure 6-1 Deploying a new plant

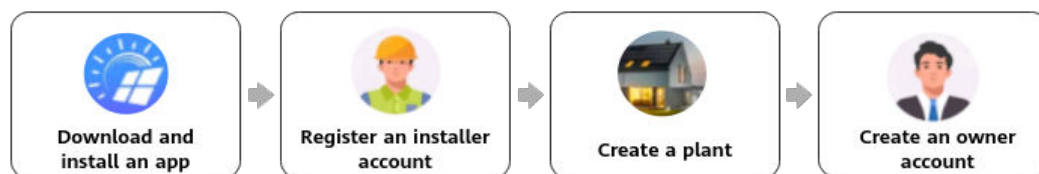

Table 6-2 Plant deployment description

No.	Task	Description
1	Downloading and installing an app	Download and install the FusionSolar app.
2	Registering an installer account	Register an installer account required for deployment and commissioning.
3	Creating a plant	Access the Setup wizard screen, scan the QR code to create a plant, commission devices according to the quick setting process, and connect devices to the plant.
4	Creating an owner account	Create an owner account that can be used to remotely monitor and manage devices.

 NOTE

For details, see [FusionSolar App Quick Guide \(SmartAssistant\)](#), or scan the QR code to download the quick guide.



6.3.2 Commissioning Functions

Commission the following functions as needed.

Table 6-3 Commissioning functions

Function	Scenario Description	Procedure
Adding Intelligent Electrical Equipment	Intelligent electrical equipment (such as SG Ready heat pumps and electrical devices controlled by smart switches) in your home can be added to the FusionSolar app for management.	For details, see FusionSolar App Quick Guide (SmartAssistant) , or scan the QR code to download the quick guide. 
Limited Feed-in	If surplus PV power is fed into the grid, the parameter of limited feed-in power can be set to ensure that the feed-in power is within the range specified by the grid company.	
Scheduling via DI Port	Applies to scenarios where the grid company performs remote scheduling through dedicated ripple control receivers. The grid company remotely delivers a scheduling command (%) to the plant with a wireless transmitting apparatus. Then, the wireless receiving apparatus receives the scheduling command and converts it into a DI signal. The SmartAssistant controls the inverter to output the corresponding power.	
Peak Shaving	Applies to areas that have peak demand charges. The capacity control function allows you to lower the peak power drawn from grid in maximum self-consumption or TOU mode during peak hours, reducing electricity fees.	

Function	Scenario Description	Procedure
Setting External WLAN Antenna Parameters	By default, the SmartAssistant has a built-in WLAN antenna. If the signal quality of the power distribution box is poor, install an external antenna to enhance WLAN signals. If an external antenna is used, set the antenna in the built-in WLAN parameters to an external antenna.	

For details about app operations, see [FusionSolar App User Manual](#).

7 Maintenance

 **DANGER**

- Wear personal protective equipment and use dedicated insulated tools to avoid electric shocks or short circuits.
-

 **WARNING**

- Before performing maintenance, power off the equipment, follow the instructions on the delayed discharge label, and wait for a period of time as specified to ensure that the equipment is not energized.
-

7.1 Routine Maintenance

To ensure that the SmartAssistant operates properly for a long term, you are advised to perform routine maintenance as described in this section.

 **CAUTION**

Before performing maintenance operations such as connecting cables, the system must be powered off.

Table 7-1 Maintenance checklist

Check Item	Check Method	Maintenance Interval
Device running status	<ul style="list-style-type: none">• Check whether the product is damaged or deformed.• Check whether the indicator status is normal.• Connect to the SmartAssistant through the app and check whether an alarm is generated.	Once every six months
Electrical connection	<ul style="list-style-type: none">• Check whether cables are securely connected.• Check whether cables are damaged, especially whether the cable sheath that contacts a metal surface is damaged.	Six months after the first commissioning and then once every 6 to 12 months

7.2 Alarm Reference

For details about alarms, see [SmartAssistant Alarm Reference](#).

7.3 Replacing a SmartAssistant

Precautions

 DANGER

- Wear personal protective equipment and use dedicated insulated tools to avoid electric shocks or short circuits.
-

 WARNING

Prior to maintenance, power off the equipment.

Procedure

- Step 1** Turn off the AC switch between the inverter and the SmartAssistant.
- Step 2** Turn off the main circuit breaker between the SmartAssistant and the grid.
- Step 3** Ensure that all LED indicators on the SmartAssistant are off.
- Step 4** Remove all electrical connections from the SmartAssistant.

Step 5 Remove the old SmartAssistant.

Hold both sides of the SmartAssistant and push it upward until the locking latches in the lower part are pressed down completely, and then rotate the SmartAssistant to disconnect it from the guide rail.

NOTICE

Do not directly remove the SmartAssistant with force. Otherwise, the SmartAssistant locking latches may be damaged.

Figure 7-1 Removing a SmartAssistant

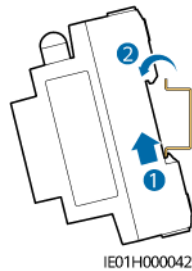

Step 6 Install a new SmartAssistant. For details, see [4 Installation](#).

Step 7 For details about the electrical connections of the SmartAssistant, see [5 Electrical Connections](#).

Step 8 Turn on the main circuit breaker between the SmartAssistant and the grid.

Step 9 Turn on the AC switch between the SmartAssistant and the inverter.

Step 10 Commission the SmartAssistant. For details, see [6.3 Commissioning the SmartAssistant](#).

Step 11 Implement device replacement on the app.

1. Log in to the remote app and tap **Device** on the home screen.
2. On the **Device** screen, tap the name of the old device.
3. Tap **::** in the upper right corner and tap **Replace device**.
4. On the **Replace device** screen, tap  to scan the QR code of the new device or enter its SN.
5. Tap **Replace**.

----End

8 Technical Specifications

Ports

AC power input	<ul style="list-style-type: none">• 100–240 V; 50 Hz/60 Hz; 63 A (maximum)• 346–415 V; 3W+N; 50 Hz/60 Hz; 63 A (maximum)• 346–415 V; 3W; 50 Hz/60 Hz; 63 A (maximum)
DI port	Two DI ports; passive relay dry contact connection supported; communications cable length ≤ 20 m; cables not routed separately; cables routed through pipes (recommended)
DO port	Two DO ports, NO and COM contacts supported; communications cable length ≤ 20 m; cables not routed separately; cables routed through pipes (recommended)
RS485 port	Two RS485 ports; baud rates: 9600 bit/s, 19200 bit/s, or 115200 bit/s
External CT port	<ul style="list-style-type: none">• Three current detection pins: IA, IB, and IC• Secondary side: 50 mA• Primary side: $N \times 50$ A ($N \geq 2$, and N is an integer)• Communications cable length ≤ 30 m; cables not routed separately; cables routed through pipes (recommended)
LAN port	One 10/100 Mbit/s adaptive port; communications cable length ≤ 100 m
WAN port	One 10/100 Mbit/s adaptive port; communications cable length ≤ 100 m
WLAN	RAT and frequency band: 802.11b/g/n (2.4–2.4835 GHz)

Current measurement range	<ul style="list-style-type: none">• Internal CT connection: ≤ 63 A• External CT connection: > 63 A
Electric energy precision	Class 1 (error within $\pm 1\%$)
Power grid system	Single-phase/Three-phase three-wire/Three-phase four-wire
Output power	<ul style="list-style-type: none">• Rated output power: 12 V@100 mA• Output voltage range: 9.5–13.2 V• Communications cable length ≤ 3 m; indoor scenario

General Specifications

Dimensions (H x W x D)	100 mm x 108 mm x 65 mm
Operating temperature	-25°C to $+60^{\circ}\text{C}$
Relative humidity	5%–95% RH (non-condensing)
Maximum altitude	4000 m (When the altitude is above 2000 m, the temperature decreases by 1°C for each additional 200 m.)
Storage temperature	-40°C to $+85^{\circ}\text{C}$
Operating power consumption	Typical: 4 W
Ingress protection (IP) rating	IP2X
Installation mode	Power distribution box guide rail installation, DIN 35 mm standard guide rail

A Resetting Passwords

You can use the password resetting function to restore the login passwords of the local WiFi AP and local installer and user accounts to the initial state.

Tool Preparation

Eject pin

Procedure

Step 1 Use the eject pin to press and hold the RST button on the SmartAssistant for 10s to 60s to reset passwords.

- WiFi AP password

The login password of the WiFi AP is reset to the initial one. You can obtain the initial password (PSW) of the WiFi AP from the laser-engraved silk screen on the SmartAssistant.

NOTE

In some scenarios, the laser-engraved silk screen on the SmartAssistant may be blurred or erased. Therefore, password-free login is supported within 3 minutes after the WiFi AP password is reset.

- Passwords of local installer and user accounts

The login passwords of the local installer and user accounts are reset to the initial ones. You can log in to the local commissioning screen to reset the login passwords.

----End

B Connecting to the SmartAssistant on the App

NOTICE

- When directly connecting your phone to a device, ensure that your phone is within the WLAN coverage of the device.
- When connecting the device to the router over WLAN, ensure that the device is within the WLAN coverage of the router and the signal is stable and good.
- The router supports WLAN (IEEE 802.11 b/g/n, 2.4 GHz) and the WLAN signal reaches the inverter.
- The WPA, WPA2, or WPA/WPA2 encryption mode is recommended for routers. The Enterprise mode is not supported (such as airport WLAN and other public hotspots that require authentication). WEP and WPA TKIP are not recommended because they have serious security vulnerabilities. If the access fails in WEP mode, log in to the router and change the encryption mode of the router to WPA2 or WPA/WPA2.

Step 1 Start device commissioning.

Figure B-1 Method 1: mobile phone connected to the Internet

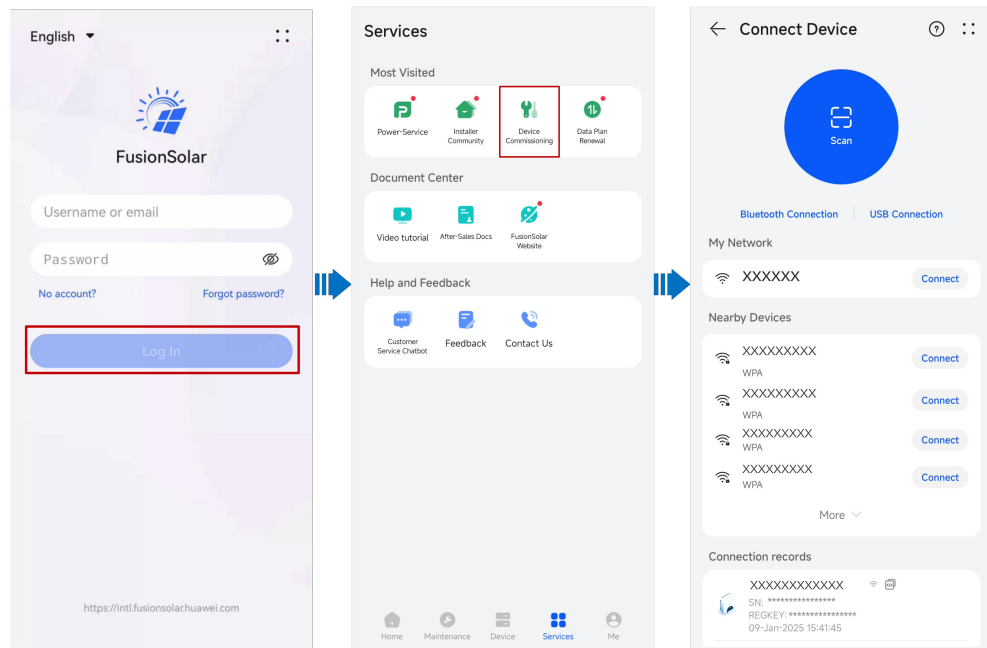
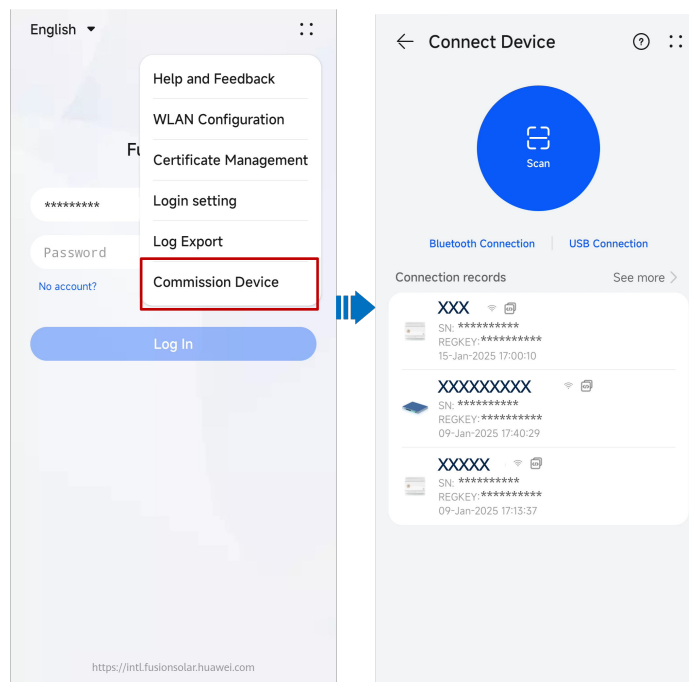

Figure B-2 Method 2: mobile phone not connected to the Internet



NOTE

Method 2 can be used only when no Internet access is available. You are advised to log in to the FusionSolar app to commission devices using method 1.

Step 2 Connect to the WLAN of the SmartAssistant.

Tap **Scan**. On the QR code scanning screen, align the QR code with the scanning box to automatically scan and connect to the WLAN of the SmartAssistant.

 **NOTE**

- SmartAssistant networking: Scan the WLAN QR code of the SmartAssistant.
- SmartGuard networking: Scan the WLAN QR code of the SmartGuard or SmartAssistant.

 **NOTE**

- The WLAN name of a product consists of "Device name-Product SN." (The last six digits of the WLAN name of some products are the same as the last six digits of the product SN.)
- For the first-time connection, log in with the initial password. You can obtain the initial WLAN password from the label on the device.
- To ensure account security, protect the password by changing it periodically, and keep it secure. Your password might be stolen or cracked if it is left unchanged for extended periods. If a password is lost, devices cannot be accessed. In these cases, the Company shall not be liable for any loss.
- If the login screen is not displayed after you scan the QR code, check whether your phone is correctly connected to the device WLAN. If not, manually select and connect to the WLAN.
- If the message **This WLAN network has no Internet access. Connect anyway?** is displayed when you connect to the built-in WLAN, tap **CONNECT**. Otherwise, you cannot log in to the system. The actual UI and messages may vary with mobile phones.

Step 3 Log in to the device commissioning screen as **Installer**.

NOTICE

- After completing the deployment settings, the installer shall remind the owner to access the local commissioning screen of the device and set the login password of the owner account as prompted.
 - To ensure account security, protect the password by changing it periodically, and keep it secure. Your password might be stolen or cracked if it is left unchanged for extended periods. If a password is lost, devices cannot be accessed. In these cases, the Company shall not be liable for any loss.
-

----End

C Certificate Management and Maintenance

C.1 Initial Certificate Risk Disclaimer

Huawei's initial certificates are mandatory identity credentials for Huawei devices before delivery. The disclaimer statements for using the certificates are as follows:

1. Huawei's initial certificates are used only in the deployment phase, for establishing initial security channels between devices and the customer's network. Huawei does not promise or guarantee the security of the initial certificates.
2. Customers shall bear consequences of all security risks and security incidents arising from using Huawei's initial certificates as service certificates.
3. Huawei's initial certificates are valid from the manufacturing date until December 29, 2099.
4. Services using an initial certificate will be interrupted when the certificate expires.
5. It is recommended that customers deploy a PKI system to issue certificates for devices and software on the live network and manage the lifecycle of the certificates. To ensure security, certificates with short validity periods are recommended.

NOTE

You can view the validity period of an initial certificate on the network management system.

C.2 Application Scenarios of Initial Certificates

File Path and Name	Scenario	Replacement
/mnt/home/cert/north_tcpmb_client_cert_old/ca_single_1.crt	Authenticates the validity of the peer management system for communication through Modbus-TCP.	For details about how to replace a certificate, contact technical support engineers to obtain the corresponding security maintenance manual.
/mnt/home/cert/north_tcpmb_client_cert_old/ca_single_0_0.crt		
/mnt/home/cert/north_tcpmb_client_cert_old/ca_single_2.crt		
/mnt/home/cert/north_tcpmb_client_cert_old/ca_single_0_1.crt		
/mnt/home/cert/tcpmb_server_cert_old/ca_single_1.crt	Authenticates the validity of the peer app when communicating with the mobile app over Modbus-TCP.	
/mnt/home/cert/tcpmb_server_cert_old/ca_single_0_0.crt		
/mnt/home/cert/tcpmb_server_cert_old/ca_single_2.crt		
/mnt/home/cert/tcpmb_server_cert_old/ca_single_0_1.crt		
/mnt/home/cert/ftp_server/ca.crt	Authenticates the validity of the peer charger when communicating with the charger through the BIN protocol.	
/mnt/home/cert/ftp_server/tomcat_client.crt		

D One-Click Network Disconnection Settings

After the **One-click network disconnection** function is enabled, the device is disconnected from Huawei management system, and all O&M services based on the management system are unavailable.

NOTE

Before using this function, ensure that the version of the FusionSolar app is 25.1.100.006 or later.

Procedure

1. **Connect to the SmartAssistant on the app** and log in to the local commissioning screen of the device.
 - Installer: Choose **Set > Communication settings > Management system settings**.
 - Owner: Choose **Set > Communication settings > Management system settings**.
2. Tap **One-click network disconnection**, enter the password for logging in to the local commissioning screen, and enable or disable **One-click network disconnection** (disabled by default).

NOTICE

- When **One-click network disconnection** is enabled, the Huawei management system cannot be connected during app-based deployment. To connect to the Huawei management system, disable **One-click network disconnection** first.
 - If the system does not automatically connect to the management system after **One-click network disconnection** is disabled, you can reconnect to the management system in **Management system settings** or **Quick Settings**.
-

Figure D-1 One-click network disconnection (installer user as an example)

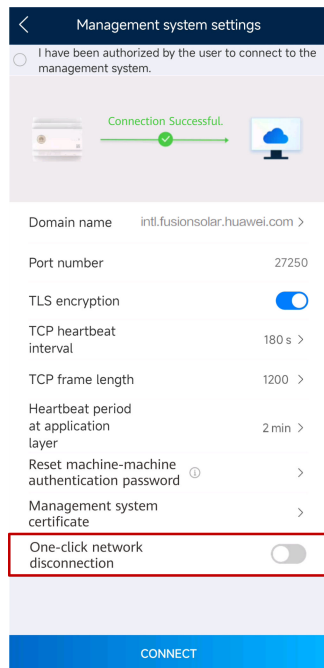

E Contact Information

If you have any questions about this product, please contact us.



<https://digitalpower.huawei.com>

Path: **About Us > Contact Us > Service Hotlines**

To ensure faster and better services, we kindly request your assistance in providing the following information:

- Model
- Serial number (SN)
- Software version
- Alarm ID or name
- Brief description of the fault symptom

 **NOTE**

EU Representative Information: Huawei Technologies Hungary Kft.
Add.: HU-1133 Budapest, Váci út 116-118., 1. Building, 6. floor.
Email: hungary.reception@huawei.com

F Intelligent Customer Service



<https://digitalpower.huawei.com/robotchat/>

G Acronyms and Abbreviations

A

AC alternating current

APP application

C

CT current transformer

D

DC direct current

DI digital input

DO digital output

E

ETH Ethernet

G

GE gigabit Ethernet

L

LAN local area network

LED light-emitting diode

M

MPP maximum power point

MPPT maximum power point tracking

N

NC normally closed

NO normally open

P

POE power over Ethernet

R

RST reset

S

SOC state of charge

SOH state of health

W

WAN wide area network